

# LED — TECH PRO

## PAN28-620\*620-CCT

| DONNEES TECHNIQUES                  |                    |
|-------------------------------------|--------------------|
| Référence                           | PAN28-6620*620-CCT |
| Puissance                           | 28 watts           |
| Température couleur & Flux Lumineux | 3000k = 3640 lm    |
|                                     | 4000k = 3920 lm    |
|                                     | 6000k = 4300 lm    |
| Angle de diffusion                  | 90°                |
| Eblouissement                       | UGR19              |
| Indice de rendu des couleurs        | IRC 80             |
| Indice de protection                | IP41               |
| MacAdam                             | SDCM 2             |
| Risque à la lumière bleu            | RG 0               |
| Variation                           | Non                |
| Température de fonctionnement       | De -20° à 45°      |
| Tension d'alimentation              | AC 200-240 V       |
| Diode                               | Epistar            |
| Durée de vie                        | 50'000 heures      |
| Garantie                            | 5 ans              |
|                                     |                    |
| SPECIFICATIONS                      |                    |
| Taille du luminaire                 | 620 x 620 x 35 mm  |
|                                     |                    |
| Option                              | DALI               |
|                                     | 0-10V              |

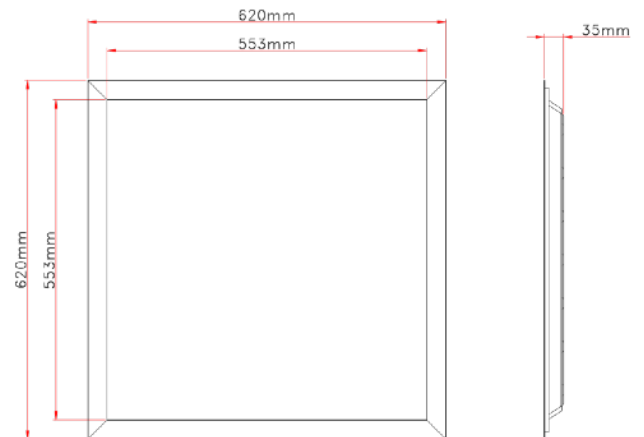

UGR<19

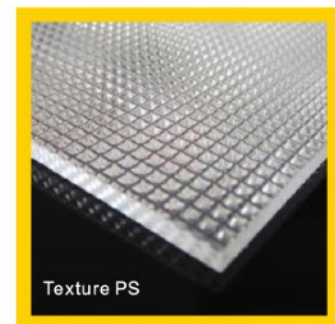

Angle 90°



# 3000K

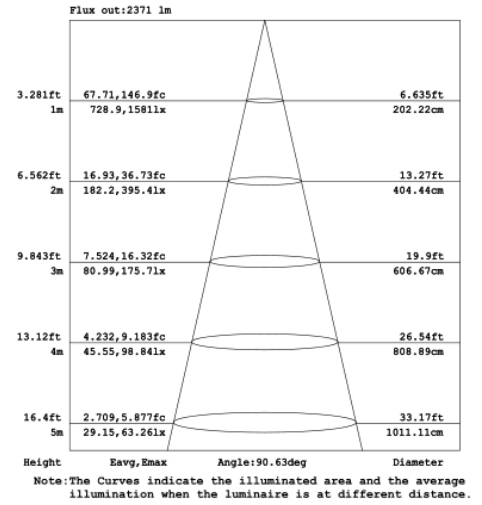
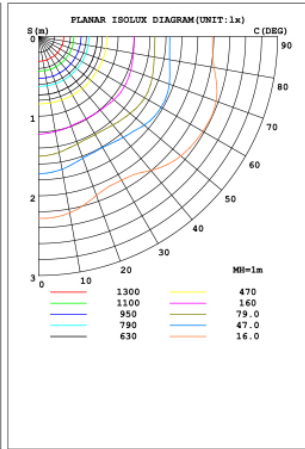
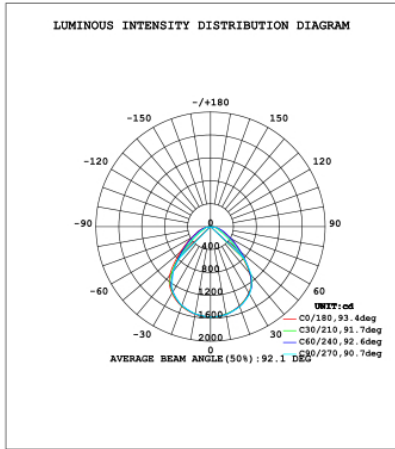

# 4000K

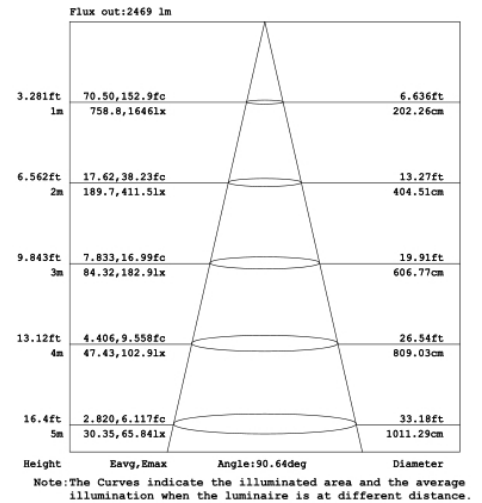
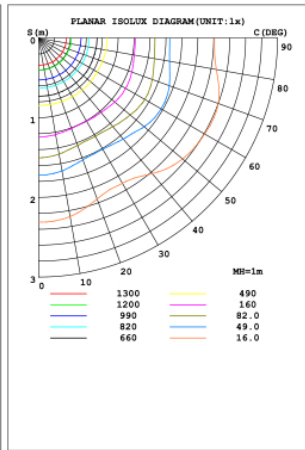
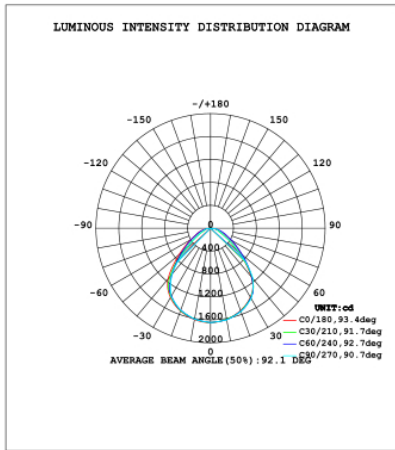

# 6000K

